

INLET, PANEL MOUNTING

Part No.	ME 330B7W
Description:	30 Amp 480Vac 2 Pole, 3 Wire Inlet
Construction:	Watertight IEC IP 67
Approvals:	UL Listed Standards 1682; 1686 CSA Certification to Spec. C22.2 No. 182.1 IEC 60309-1; IEC 60309-2

IEC COLOR CODE: Red

GROUND SOCKET: 5 Hour Position Mates with Female in 7 Hour Position.

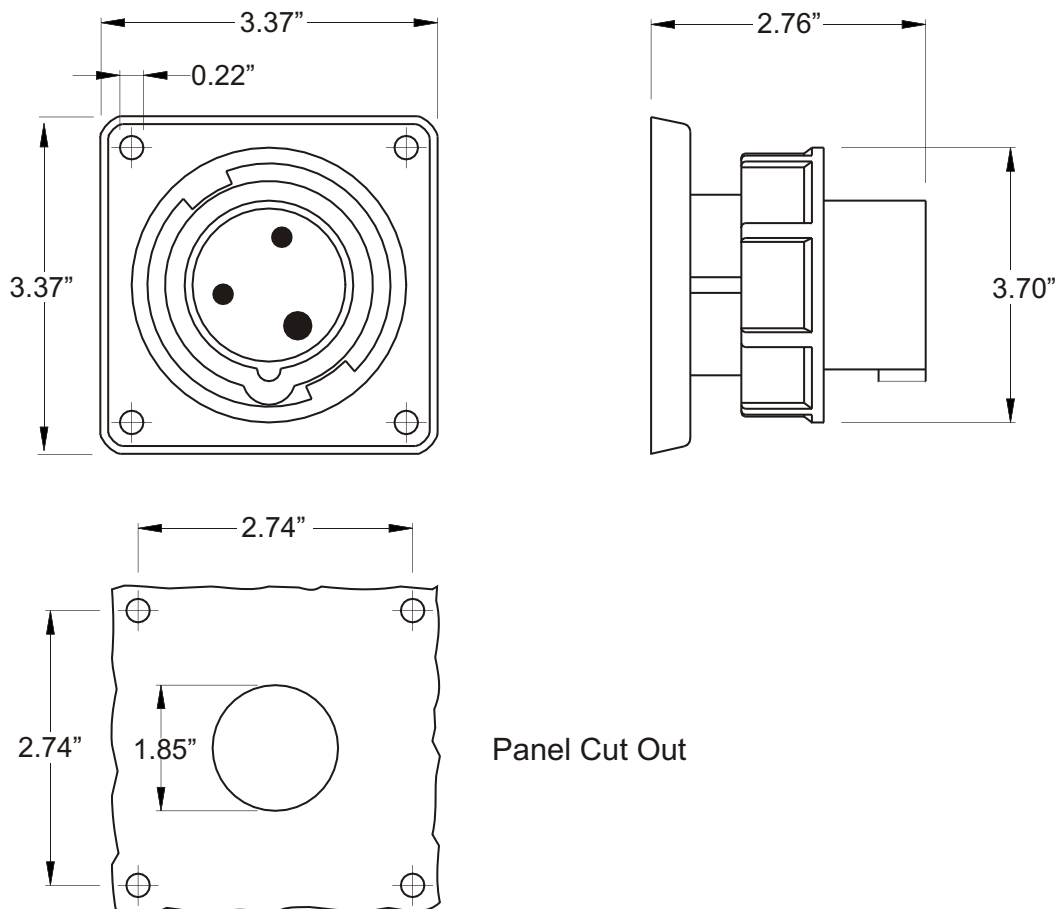

Wire Range: #8 - #12 AWG

Drawing Not to Scale